

INSTRUCTION MANUAL FOR STRAIGHT DISC & DIE GRINDERS

Operation Procedures

For Die Grinder

1. Connect the coupler to the air inlet ① .
2. Make sure the diameter of the collet ② fits to the diameter of the grinding stone with shaft. (Standard : 6mm Option : 1/4 inch)
3. Firmly insert the axis of abrasive accessories such as a grinding stone with shaft into the collet nut ③ from 15mm to 20mm depth.

4. When the grinding stone is installed, fix the collet ④ at the 14mm spanner wrench, and firmly tighten the collet nut ③ at the 17mm spanner wrench.

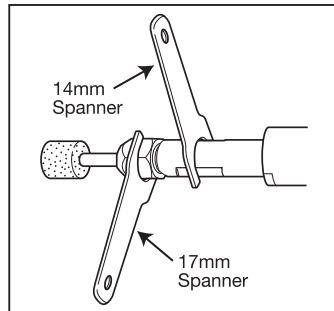

5. When the grinding stone with shaft is inserted, be sure to maintain 13mm to the distance between such abrasive accessories and collet chuck, so-called the overhang.

※The maximum operating speed is calculated when the overhang is 13mm.

6. Pour approx. 0.5cc (2 to 3 drops) of the oil through the coupler. Connect it to the air hose, and run for 3 to 5 seconds to circulate the oil.

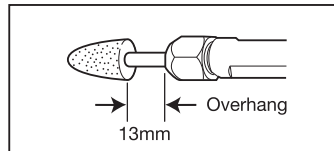

7. Switch consists of two types of ⑤ "Rotary twist switch"(SI-SG3-CR) and ⑥ "Safety lever"(SI-SG3-CL).

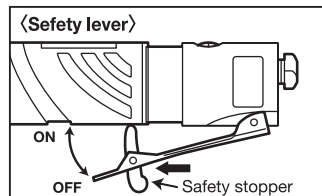
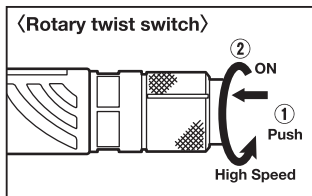
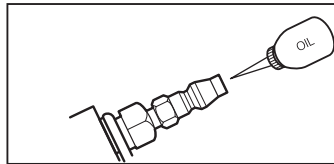

8. If the grinding stone can not be removed, slightly hit the collet nut ③ unit with a wooden hammer, spanner etc., so as not to give any damage. Then, the grinding stone will be easily removed.

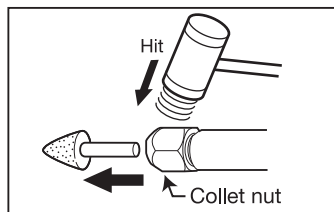

For Disc Grinder

1. Connect the coupler to the air inlet ① on the rear side of tool.

2. Make sure the disc cover ② is firmly mounted in place.

3. Pour approx. 0.5cc (2 to 3 drops) of the oil through the coupler. Connect it to the air hose, and run for 3 to 5 seconds to circulate the oil.

4. When the grinding stone is installed, fix the Disc Receiver ④ at the 21mm spanner wrench and firmly tighten the nut ③ at 17mm spanner wrench.

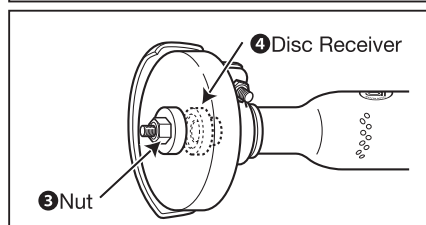
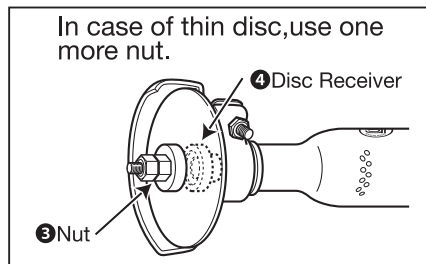

5. Switch consists of two types of ⑤ "Rotary twist switch"(SI-SG3-2R, SI-SG3-3R) and ⑥ "Safety lever"(SI-SG3-2L, SI-SG3-3L).

Die Grinders

SI-SG3-CR

Max.rpm:14,000rpm

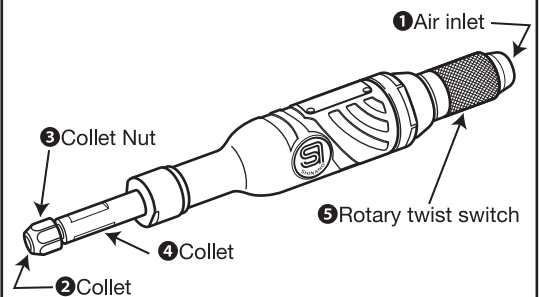

Accessories : Spanner (2),
Safety instructions (1)

SI-SG3-CL

Max.rpm:14,000rpm

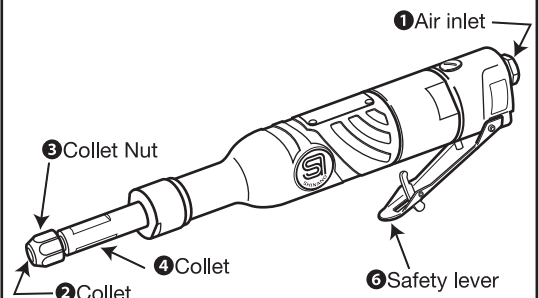

Accessories : Spanner (2),
Safety instructions (1)

Disc Grinders

SI-SG3-2R
SI-SG3-3R

Max.rpm:14,600rpm

Max.rpm:12,700rpm

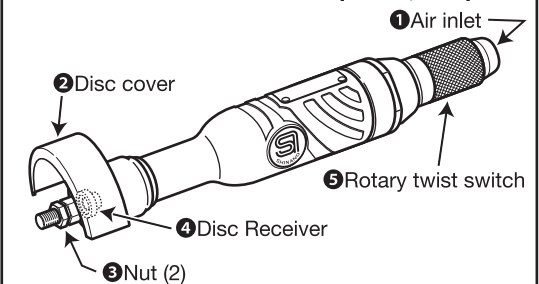

Accessories : Spanner (2),
Safety instructions (1)

SI-SG3-2L
SI-SG3-3L

Max.rpm:14,600rpm

Max.rpm:12,700rpm

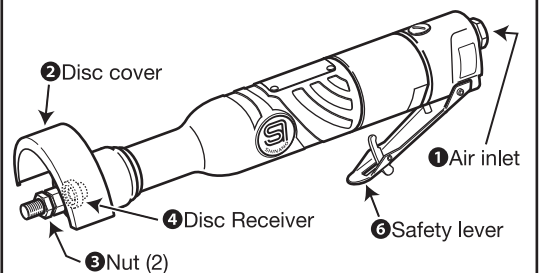

Accessories : Spanner (2),
Safety instructions (1)

Noise Level and Vibrations

Model Number	Noise Level (db) Press / Power (ISO 15744-2008) (ISO 11203-2009)	Vibration (m/s ²) (ISO 28927-12)	
		m/s ²	K
SI-SG3-CR	83.5 / 94.5 K 0.53 / K 0.36	2.86	0.78
SI-SG3-CL	83.5 / 94.5 K 0.53 / K 0.36	2.86	0.78
SI-SG3-2R/SG3-3R	83.5 / 94.5 K 0.53 / K 0.36	2.86	0.78
SI-SG3-2L/SG3-3L	83.5 / 94.5 K 0.53 / K 0.36	2.86	0.78

WARNING –DIE GRINDER–

- Never use the tool beyond the maximum circumferential speed and rpm indicated on the tip tools such as grinding stones.
- The grinding stones rotates at the full speed. Therefore, if the holding power is insufficient, the abrasive accessories will burst out, which is dangerous. Firmly and securely mount it onto the collet chuck.
- Usually inspect the tool if any damage or failure such as abnormal abrasion is found on the collet chuck. If any failure is found, immediately stop operations of tool, and replace it with the normal product.
- Before use, usually inspect no split, chip, and crack is found abrasive accessories such as grinding stones.

WARNING –DISC GRINDER–

- Never use the edge of grinding stone.
- Never use without the disc cover.
- Never install the grinding stone where failure such as breakage, abnormal abrasion, crack, and chip has been found.
- Confirm operations within the maximum circumferential speed and rpm, as indicated on the grinding stone.
- Before use, make sure the grinding stone is firmly installed to the tool in place and no misalignment.

CAUTION

- Careless drop of the tool will result in damage of the tool or components. Therefore, be sure to politely handle the tool.
- Operate the tool within the air pressure of 0.63Mpa (6.5kg/cm²). If operated in high pressure, the maximum allowance speed will be exceeded, which may result in damage of components.
- Before or after daily use, lubricate a few drops of air tool oil from the hose attached port.
- The compressed air containing dust or/and moisture will result in damage of tool. Be sure to operate the tool with air through the drainage and air filter.
- If revolution failure or/and irregular noise occurred, do not continue operation furthermore. Forced operation of tool may result in serious troubles.
- Regarding to this product, if inconvenient claims or troubles occurred, contact the product distributor.